

GL-TURBO

GL-8

Geared Turbo Blower

PRESSURE PERFORMANCE

(Based on 1 Atmosphere, 68F/20°C, 36% RH)

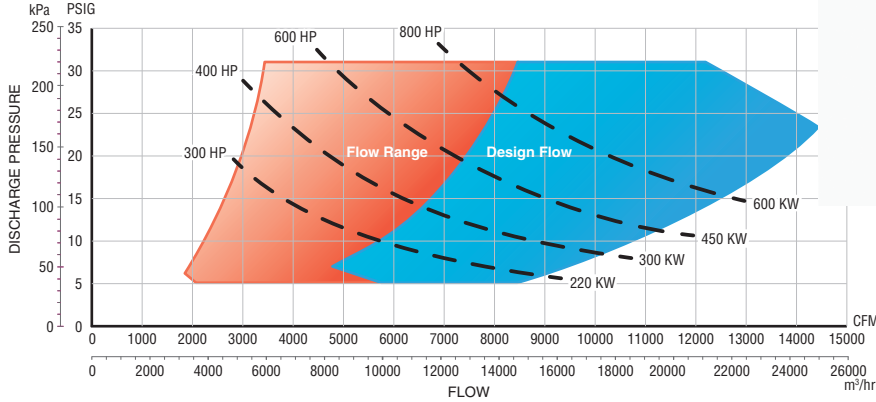

Combined Inlet and Discharge Guide Vane Control for Maximum Flow Range

Standard Specifications

Flow Capacity	See Performance Chart
Gas	Air, Steam, H ₂ S, Biogas or custom gas configuration
Flow Range	100% to 45% of rated flow with combination control
Pressure Range	20-200 kPag, 5-30 PSI
Power Range	220 -600 kw, 300-800 hp
Standards	API 617, API 672, API 614 on request
Perform. Test Procedure	ISO 5389, ASME PTC10, ASME PTC13
Balance Procedure	ISO 1940/1 Gr. 2.5
Quality	ISO 9001, ISO 14001
Noise Level	88 – 91 dB(A) without enclosure 75 – 78 dB(A) with enclosure
Vibration	< 2.8 mm/s per ISO 10816-1
Gearbox	Helical gear sets
Bearings	Hydrodynamic bearings, tilting pad type on pinion shaft
Seal Arrangements	Labyrinth, Carbon Ring, Mechanical
Control System Options	Combination inlet and discharge guide vane, Variable diffuser vane, Variable inlet guide vane, Variable speed control or Blow off control

Standard Package

PLC	Siemens S7* / Allen Bradley Compact Logix*
HMI	Siemens TP900 / Allen Bradley 2711
Pressure Sensors	IP55 4-20mA transducers
Temperature Sensors	IP55 4-20mA transducers
Inlet Filter/Silencer	GLT designed 99% at 5 microns
Expansion Joint	DIN EN 1092 / 150# Flanged
Silenced Discharge Cone	Fabricated and painted
Local Control Panel	IP56, IP65 / NEMA 12, NEMA 4X or custom
Blower Driver	Electric induction motor 2 pole 50/60 Hz, steam-turbine, combustion engine
Total Weight	(See chart on back side)
Discharge Velocity	20 m/s , 65.6 ft/s
Standard Color	RAL 5005 (signal blue)
Oil Cooling	Air or external liquid to oil
Oil Pump Type / Capacity	N340HVB 98L/min, 25G/min
Oil Filter Type	HYDAC LPF BN/HC 280 G E 20 C 1.2/-A2-B3
Oil Type	ISO VG46 Retention time 5 min

Material Specifications

Casing:	
Volute and Gearbox	Grey iron GGG40
Inlet/ Discharge	
Guide Vanes	Stainless steel 304
Impeller	Aluminum Alloy, Stainless, Titanium
Gears	High tensile alloy steel 20CrNiMo
High Speed /	
Low Speed Shaft	High tensile alloy steel 20CrNiMo
Bearings	Alloy steel with white PAP alloy
Coupling	Alloy steel 40Cr
Filter Material	Synthetic fiber
Enclosure	Galvanized steel
Base Frame	Structural steel
Machine Mounts	St. SIS 1312 for inertial damping with rubber hardness 60

Safety Monitoring

Surge	Anti surge switch
Temperature	Inlet, oil reservoir, oil cooler, enclosure
Oil Pressure, Oil Level	Oil reservoir
Delta Pressure	Inlet and outlet

Auxiliaries

Electrical Actuators	Electric modulated IP67 with positional control
Blow Off Valve	DN150 / 6" ANSI
Cooling Fan	IP55 50/60 HZ
Check Valve	Dual plate
Flange	DN300 / 12" ANSI
Inner Diameter	(No Flange) Ø450

* Information is approximate and can change without notice

GL-8

Dimensional Drawings

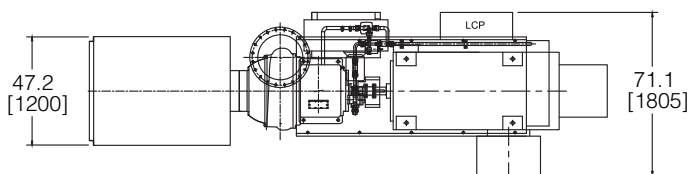
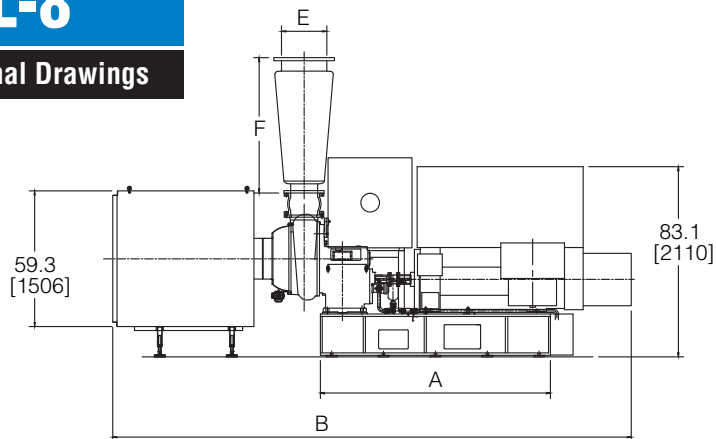
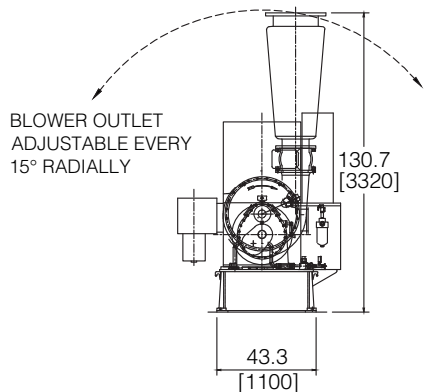

Motor HP (KW)	A IN (MM)	B IN (MM)	C IN (MM)	D IN (MM)	E ANSI (DIN)	F IN (MM)	Weight LBS (KG)
300 (220)	100.4 (2550)	226.4 (5750)	243.4 (6180)	181.1 (4600)	20 (500)	59.1 (1500)	13625 (6180)
					24 (600)	66.9 (1700)	
400 (300)	100.4 (2550)	226.4 (5750)	243.4 (6180)	181.1 (4600)	20 (500)	59.1 (1500)	13625 (6180)
					24 (600)	66.9 (1700)	
600 (450)	100.4 (2550)	226.4 (5750)	243.4 (6180)	181.1 (4600)	20 (500)	59.1 (1500)	13845 (6280)
					24 (600)	66.9 (1700)	
800 (600)	100.4 (2550)	226.4 (5750)	243.4 (6180)	181.1 (4600)	20 (500)	59.1 (1500)	14286 (6480)
					24 (600)	66.9 (1700)	

Standard Configuration

With Sound Enclosure

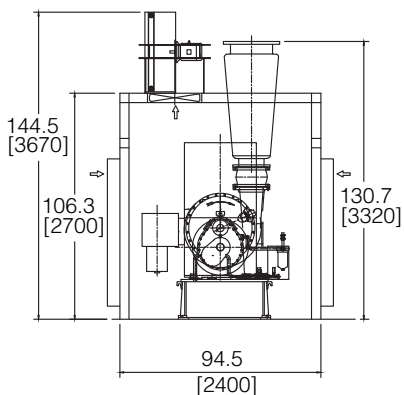
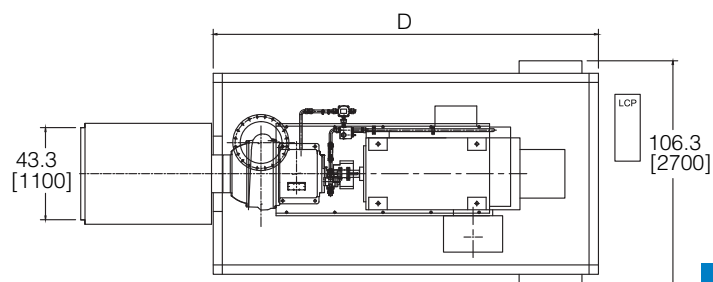
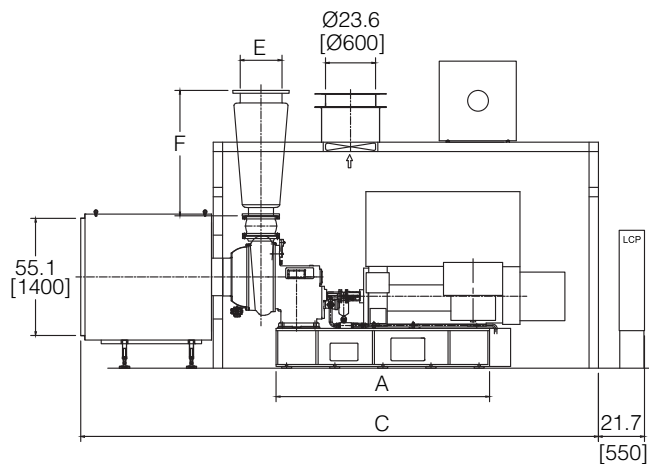

GL-TURBO

info@glturbo.com
www.glturbo.com